

1.5mm x 6mm Unterlegen

T10

T9

T8

T7

T6

T5

T4

T3

T18

T19

T19

T17

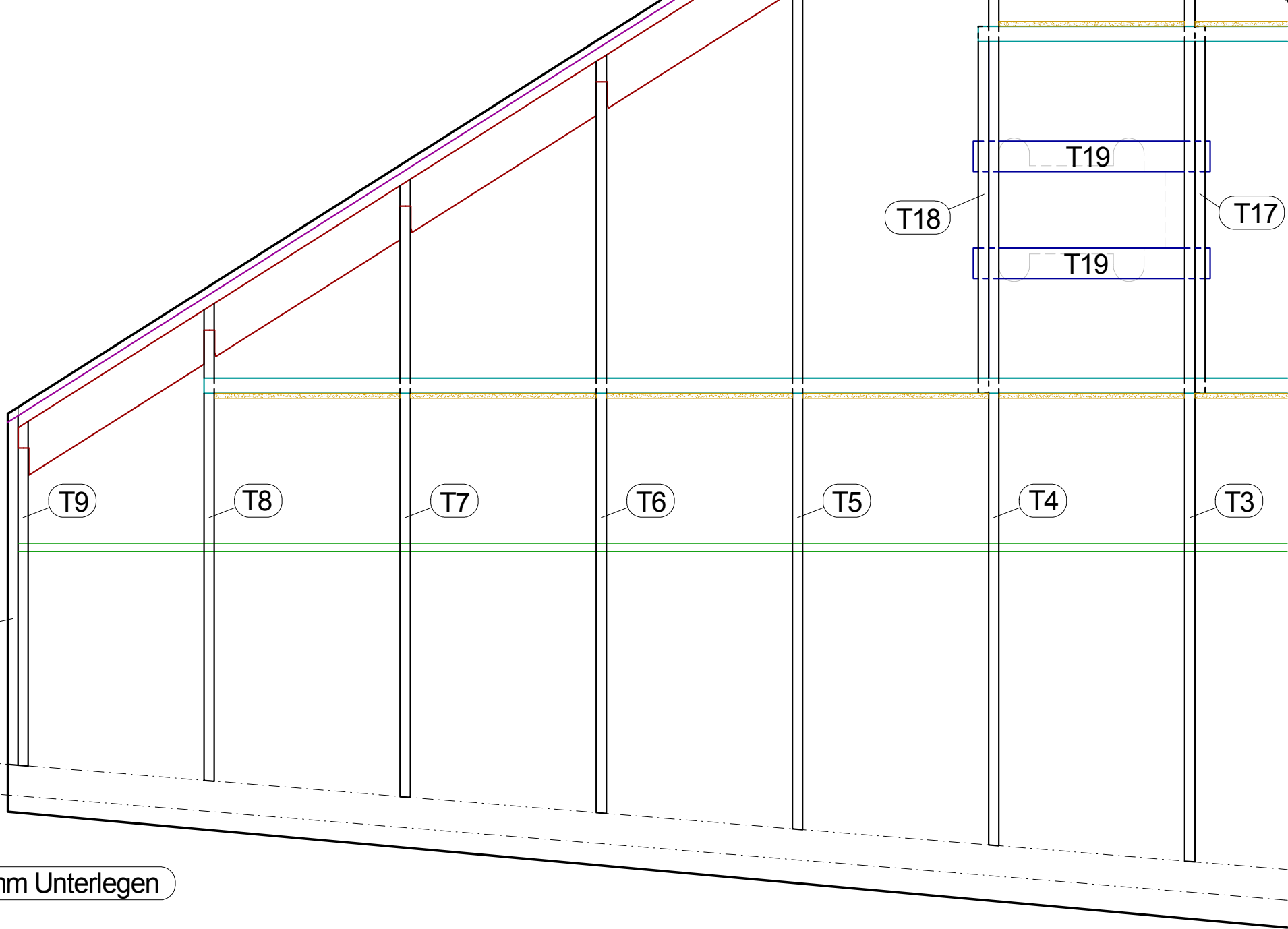

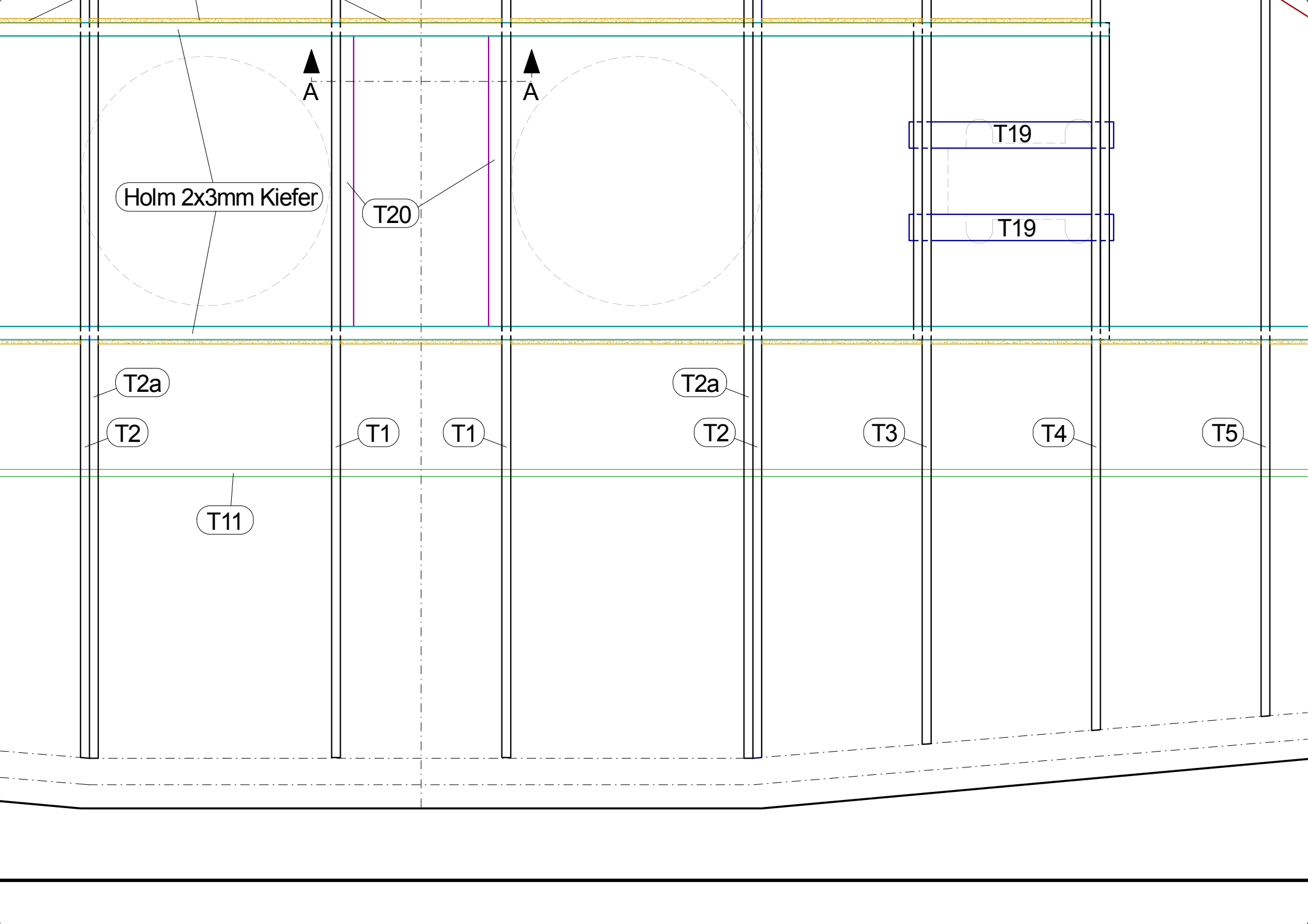

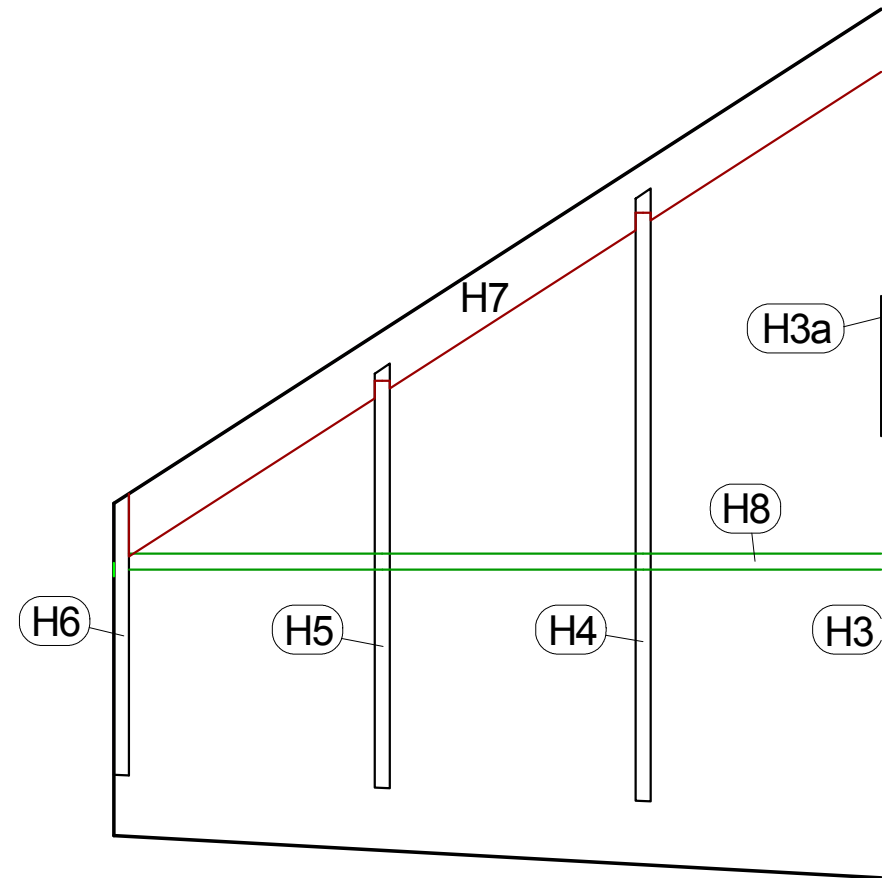
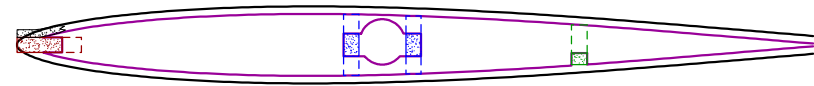
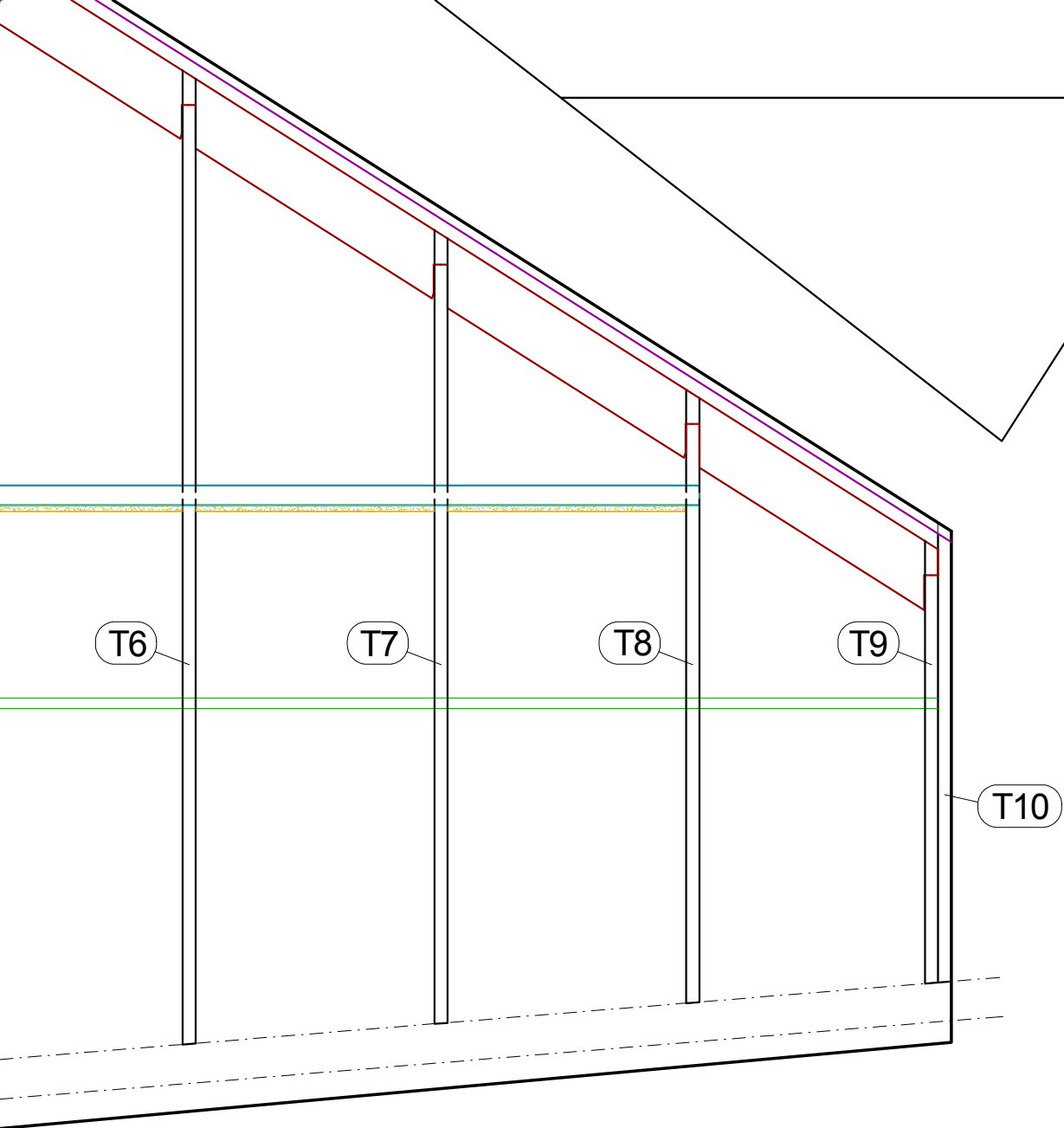

2Stk.

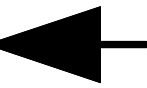
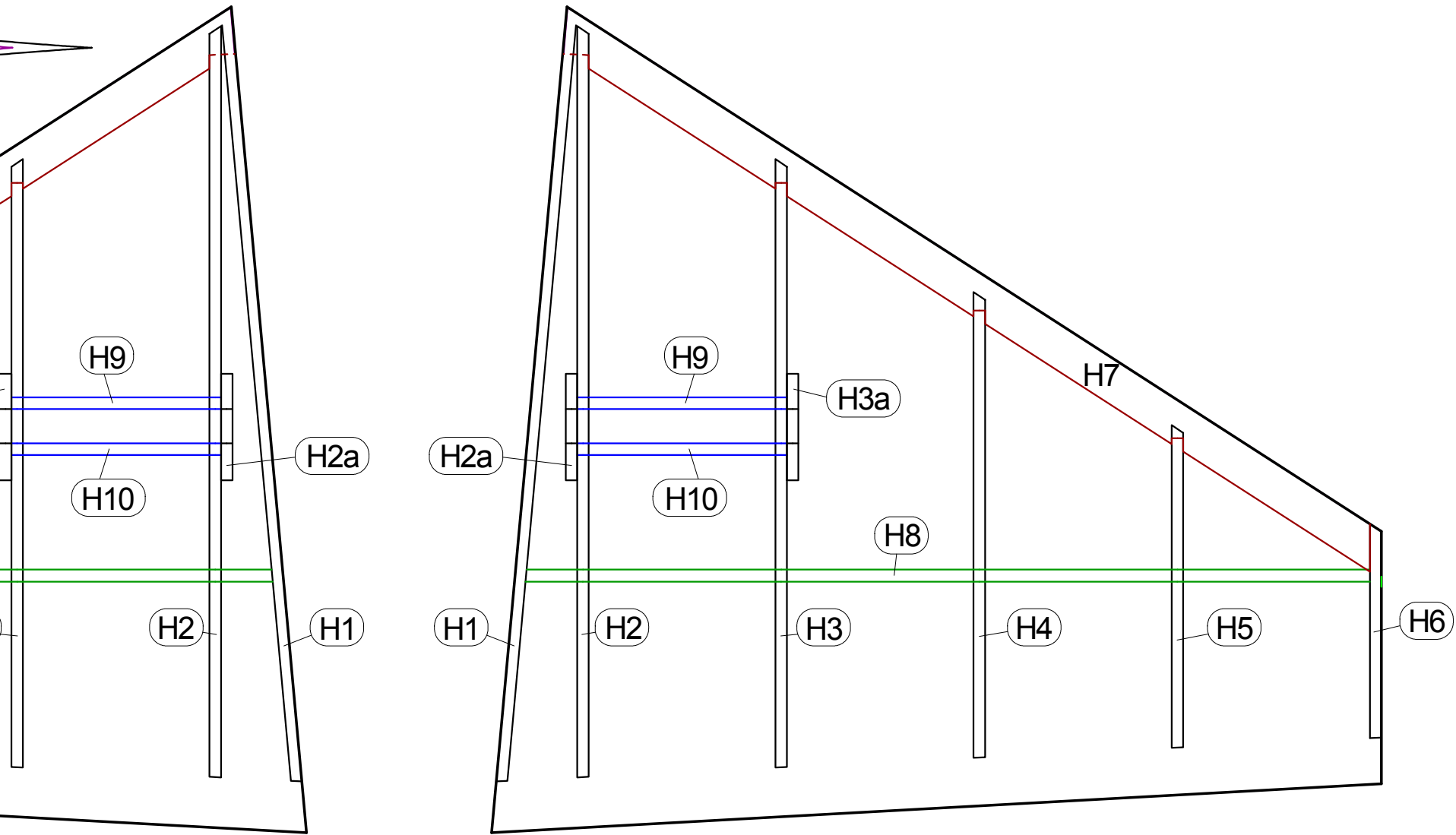

0mm

<b>F-2</b>
Spannweite
Länge
Gewicht
Antrieb
Akku
Flügel und
Komplett

/

Faserrichtung

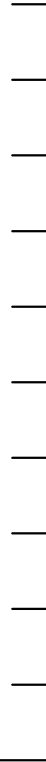

Freiwillige Spende auf PayPal-Konto  
modellbau-weibel@bluewin.ch

100mm

## 20 Tigershark M 1:11

te: 700mm  
: 1300mm  
b: 1450g  
: Wemotec Mini fan evo Het 2W20  
: 4S 3000-3500mAh

d Höhenleitwerk

Martin Weibel  
modellbau-weibel@bluewin.ch  
www.modellbau-weibel.ch

# Schnitt A-A

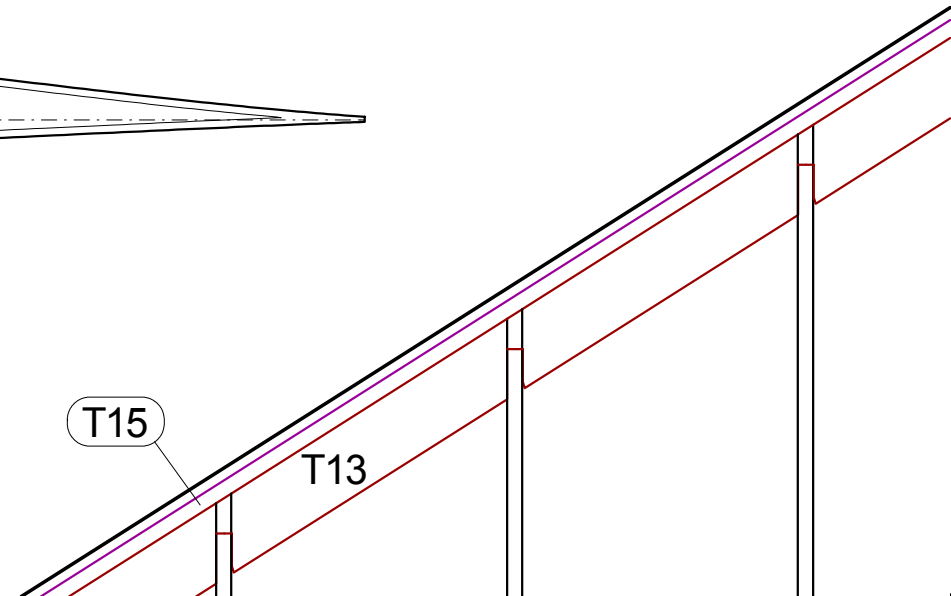
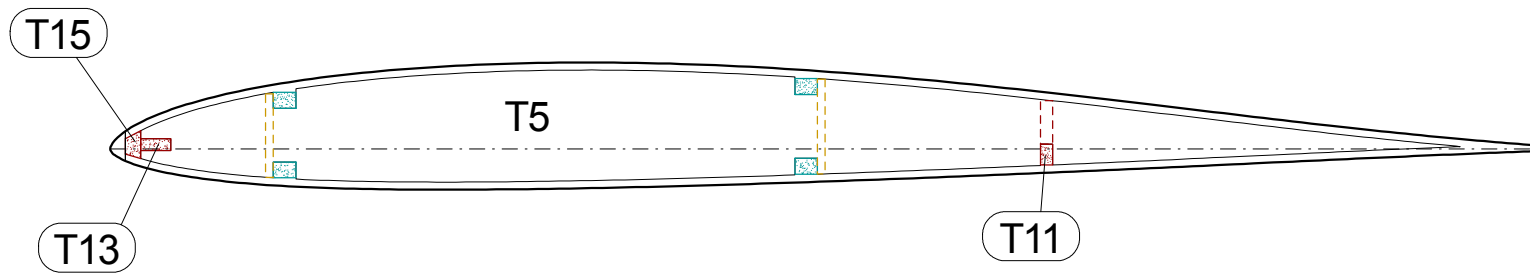
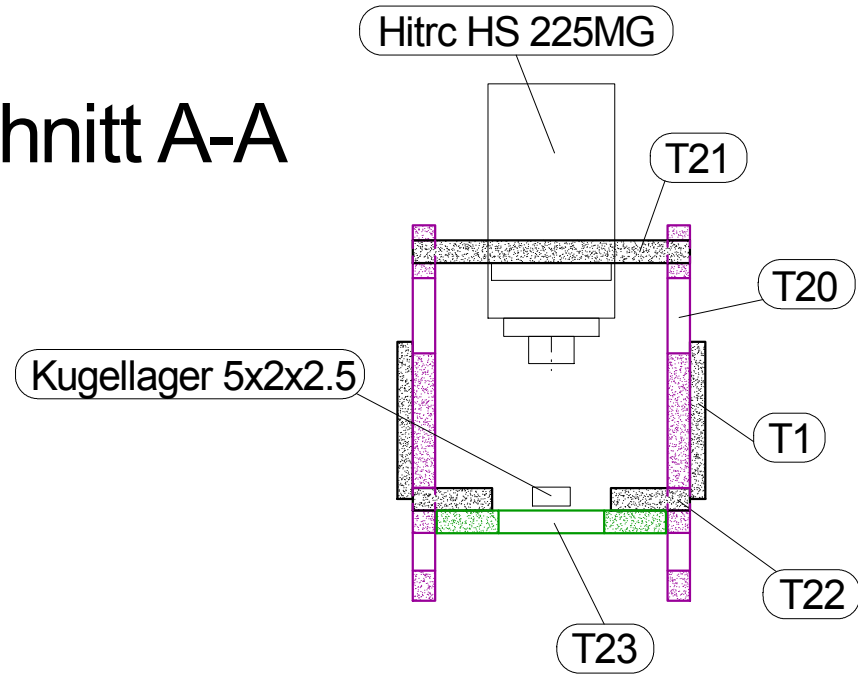

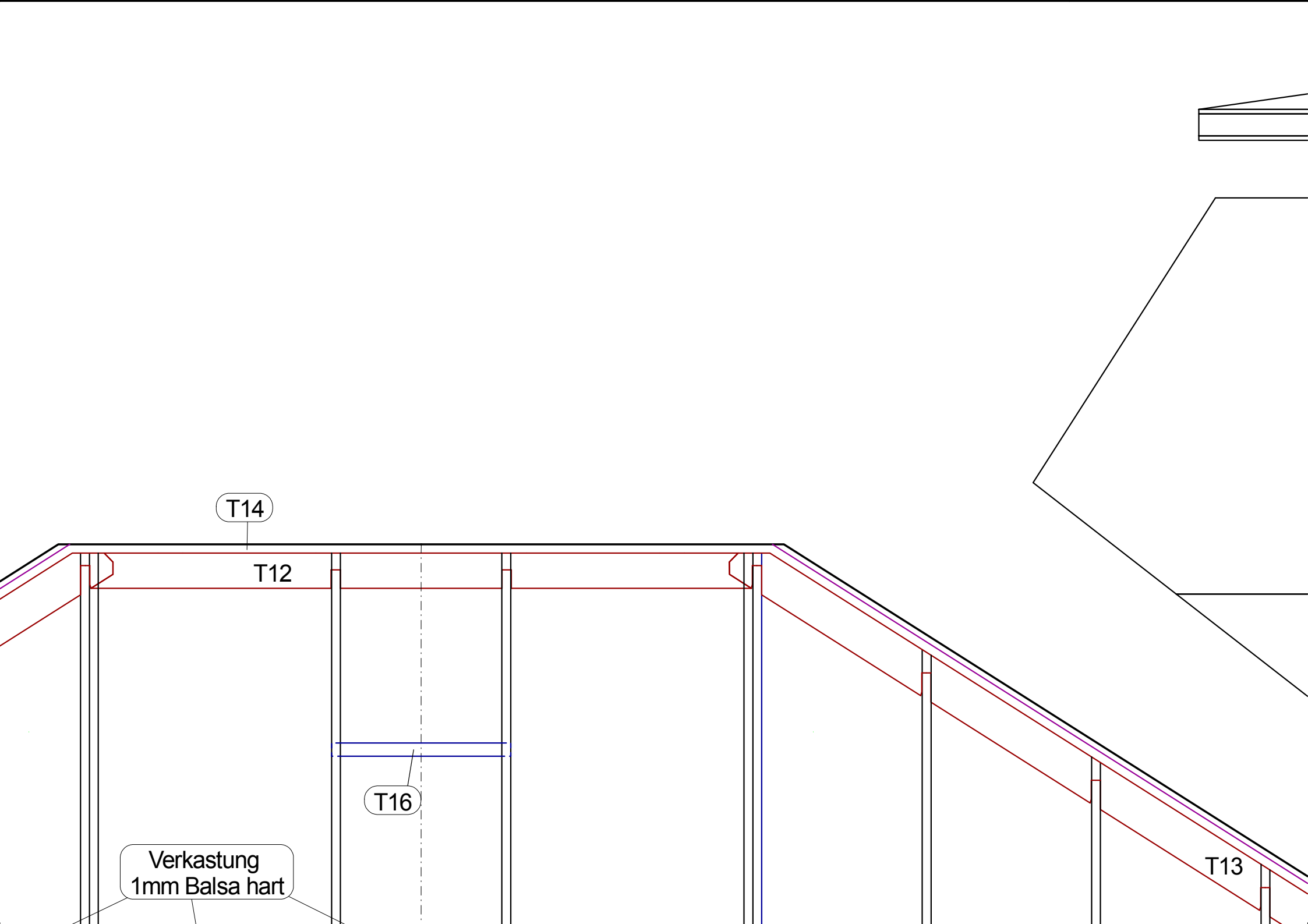

T14

T12

T16

Verkantung  
1mm Balsa hart

T13

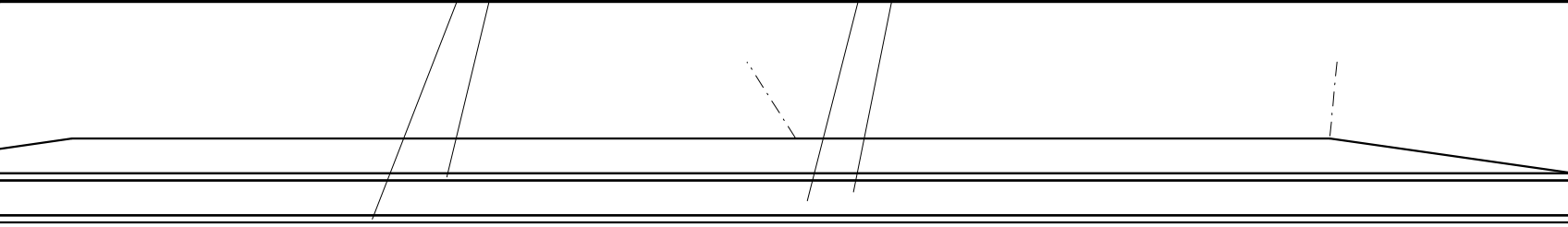

2Stk.

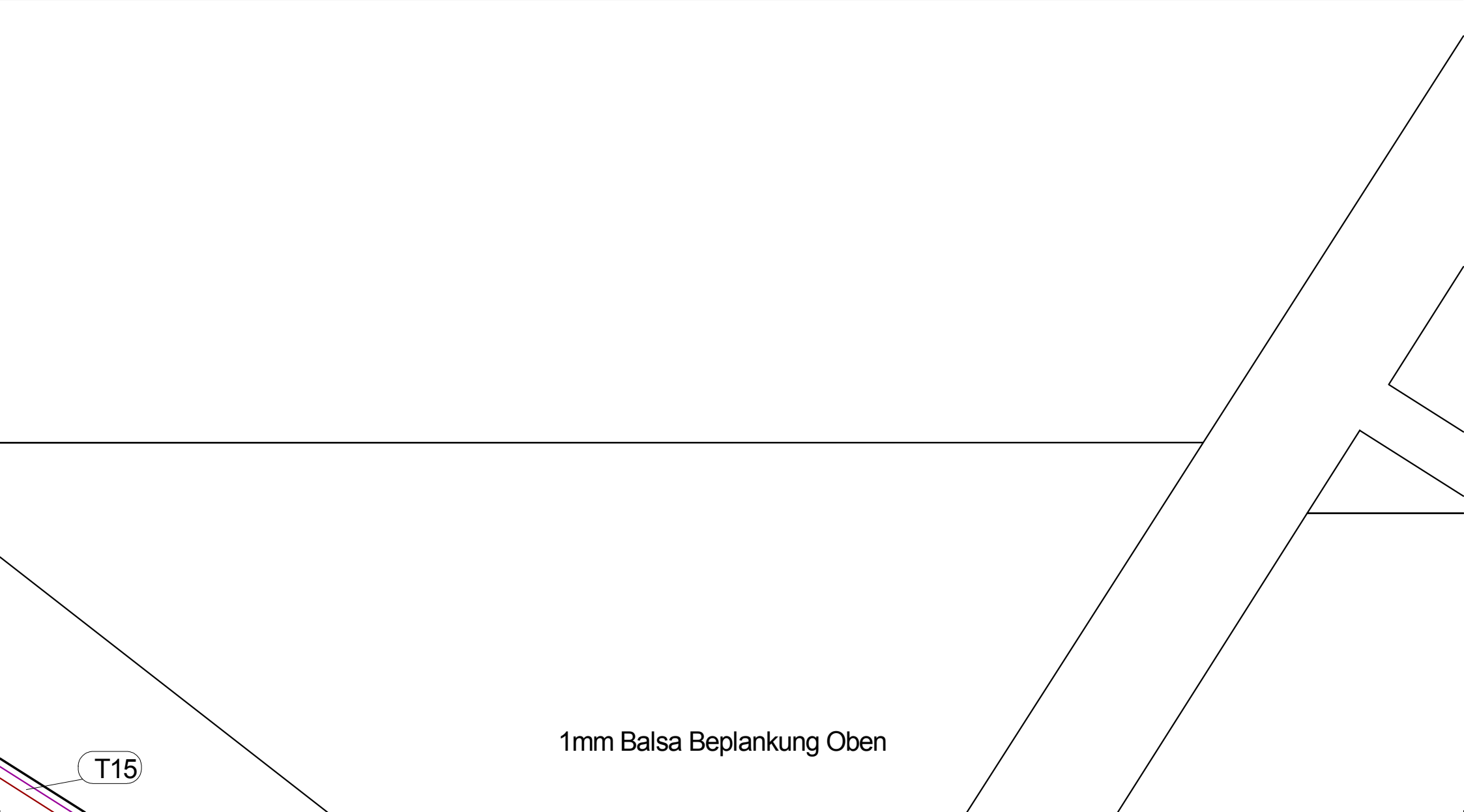

1mm Balsa Beplankung Oben

T15



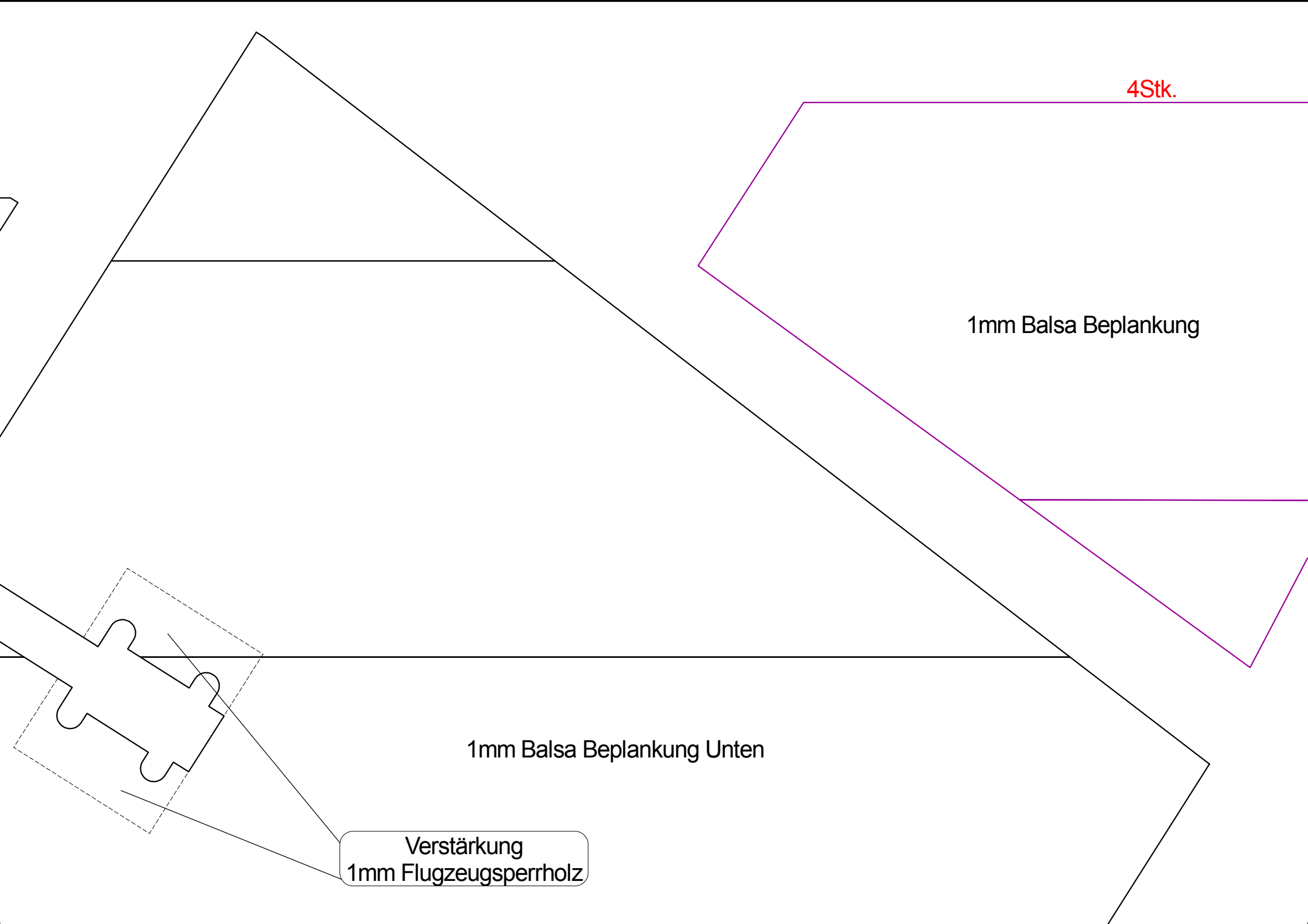

4Stk.

1mm Balsa Beplankung

1mm Balsa Beplankung Unten

Verstärkung  
1mm Flugzeugsperrholz

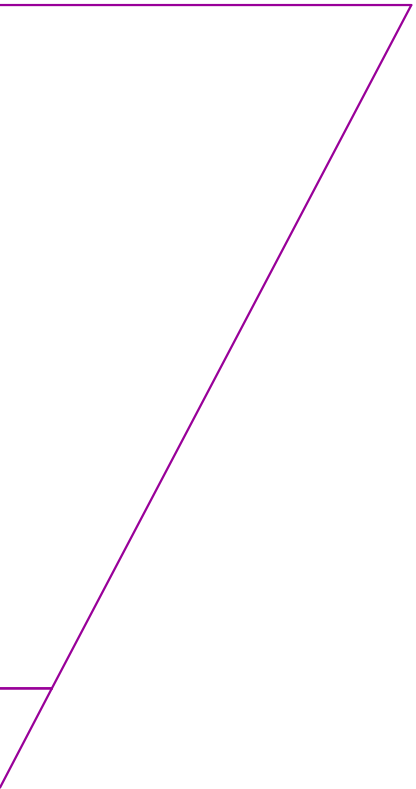

4Stk.

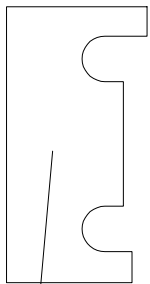

Verstärkung  
1mm Flugzeugsperrholz

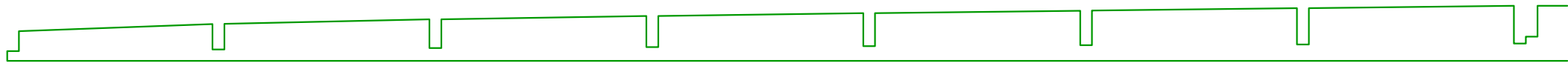

2Stk.

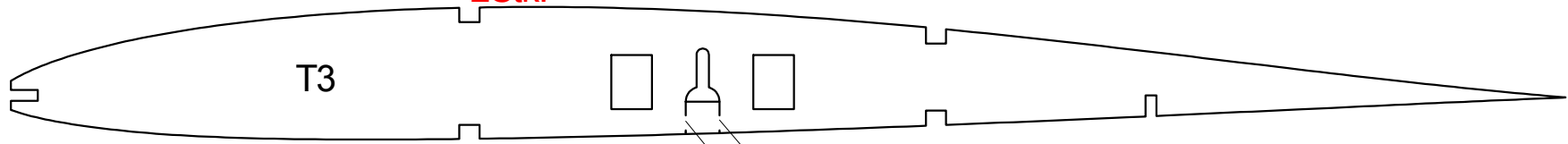

T3

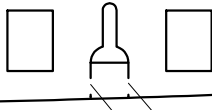

Nach dem Zusammenbauen ausschneiden

2Stk.

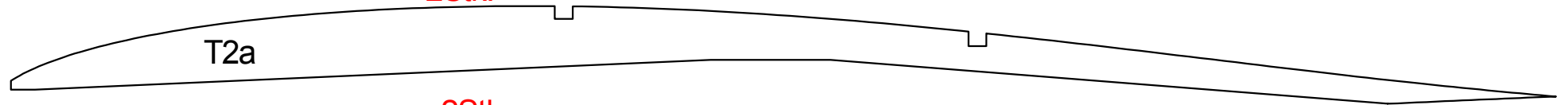

T2a

2Stk.

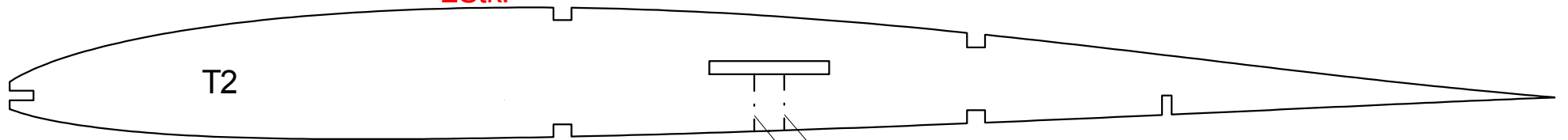

T2

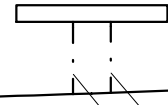

Nach dem Zusammenbauen ausschneiden

2Stk.

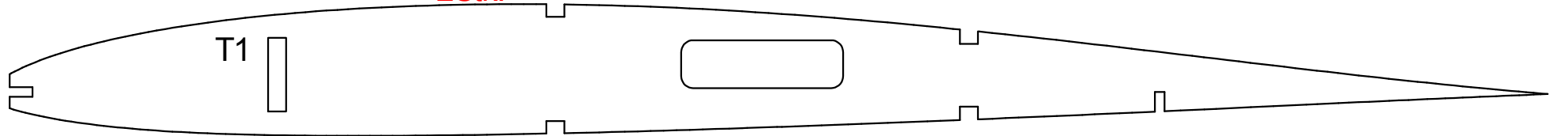

T1

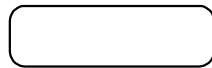

2Stk.



T13

Balsa 1.5mm

T11

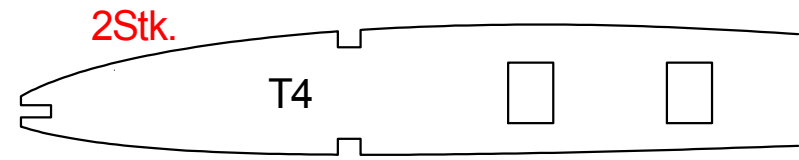
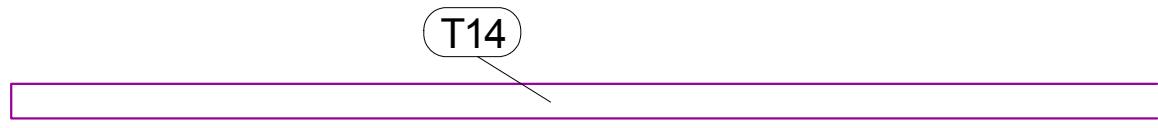
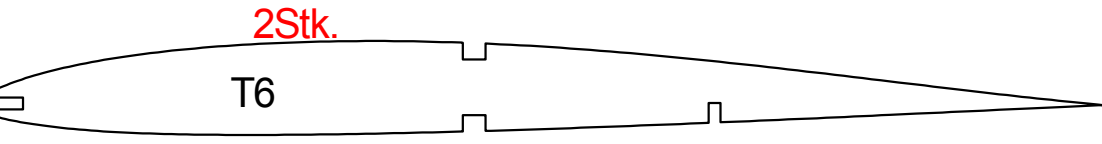
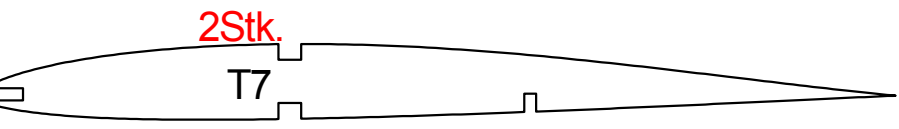
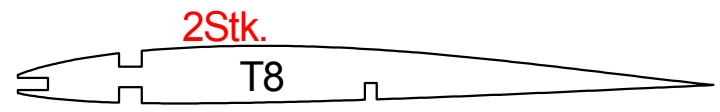
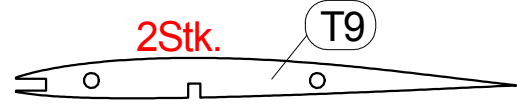
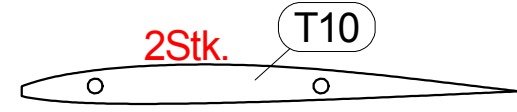

Balsa 2mm

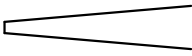
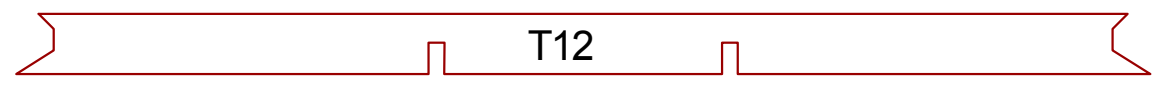

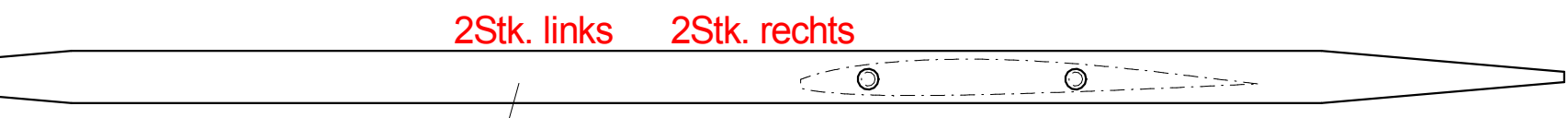
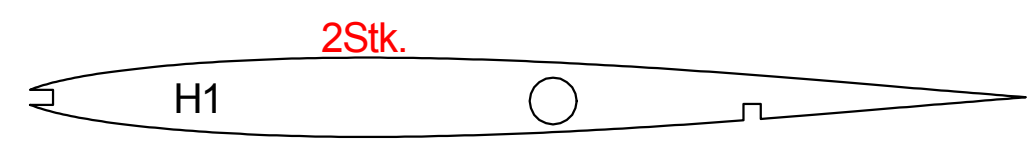
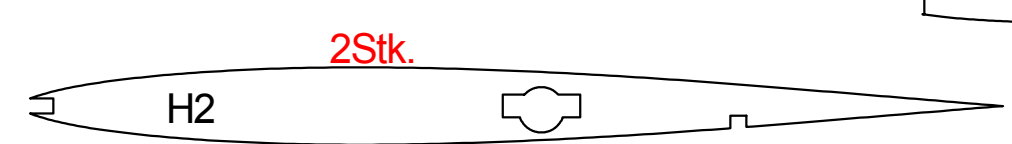
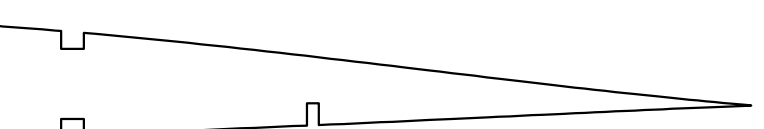
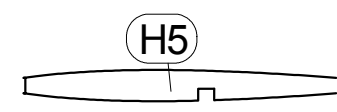
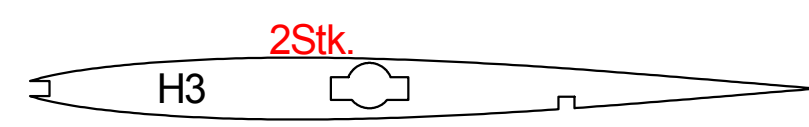
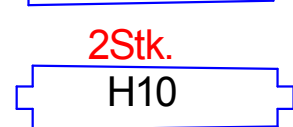
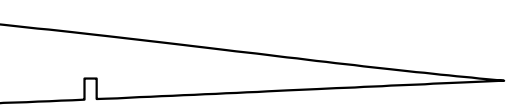
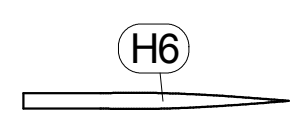
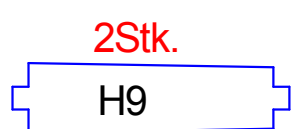
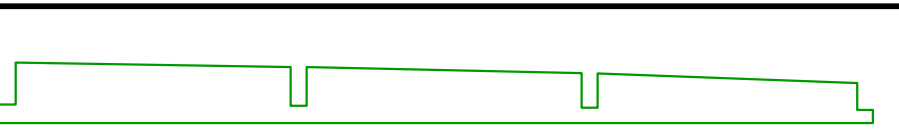

Waffenträger aus 1mm Flugzeugsperrholz und 5mm Balsa

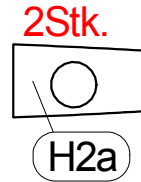
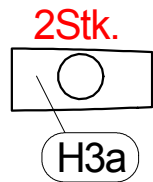
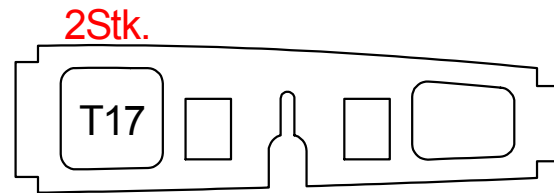
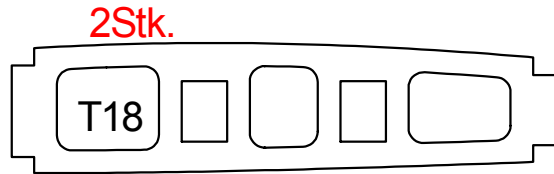

Flugzeugsperrholz 2mm



Pappel 6mm

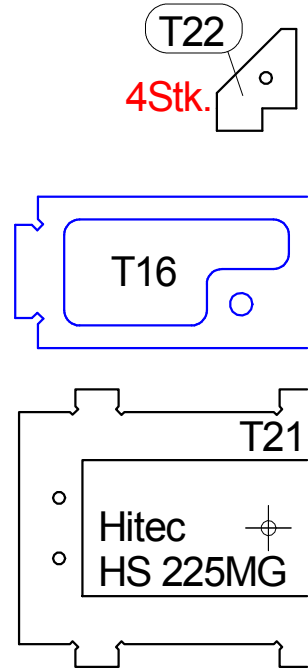

Pappe

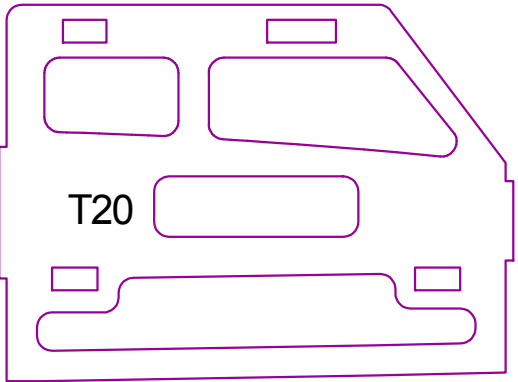

T20

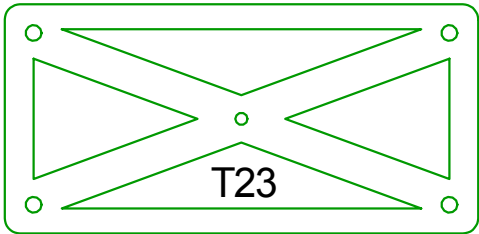

T23

el 3mm