

2Stk.

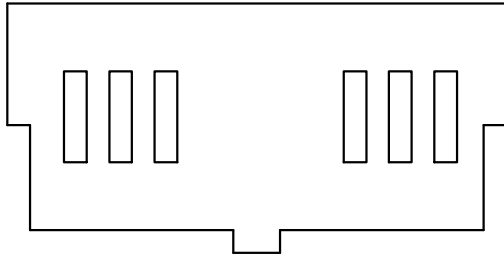

Optionale Akkubreite 2Stk.

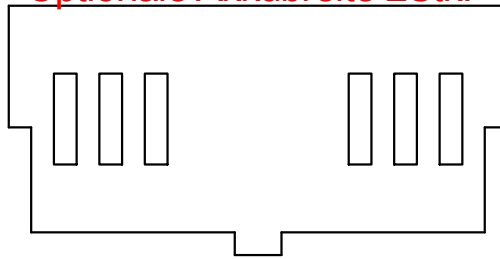

4Stk.

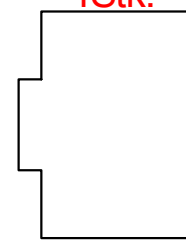

2Stk.

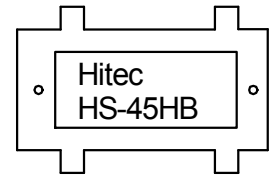
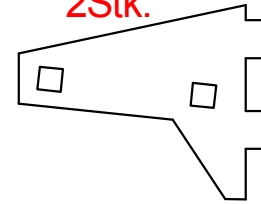

2Stk.

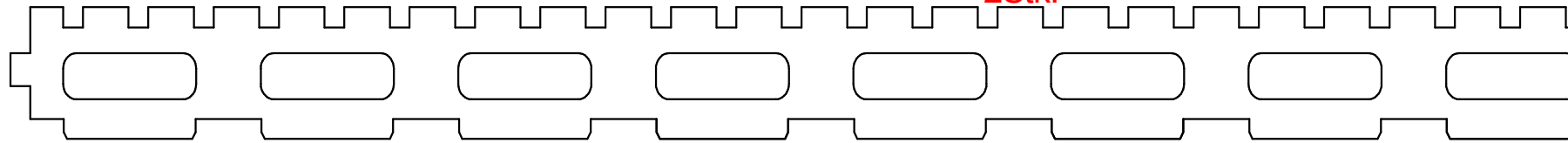

R4

R5

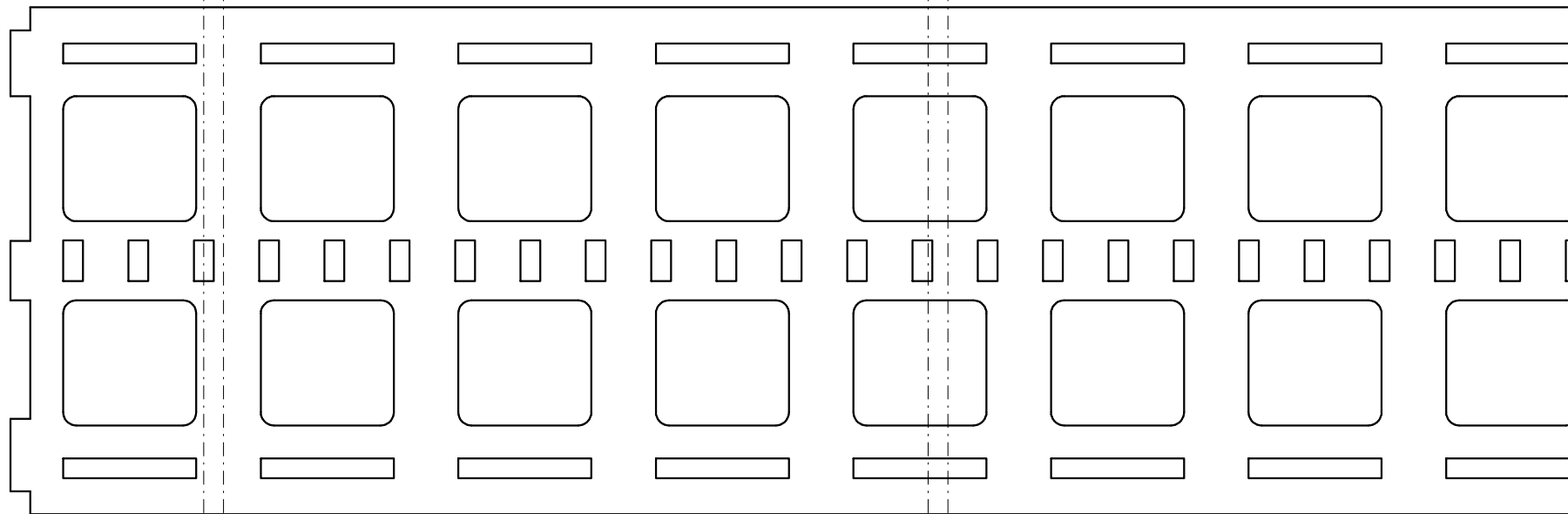
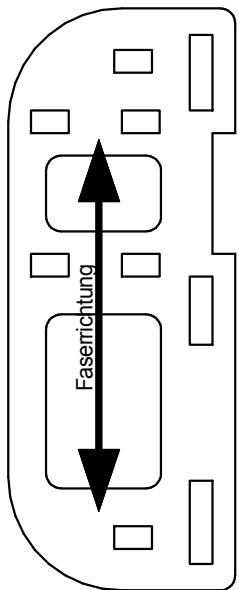

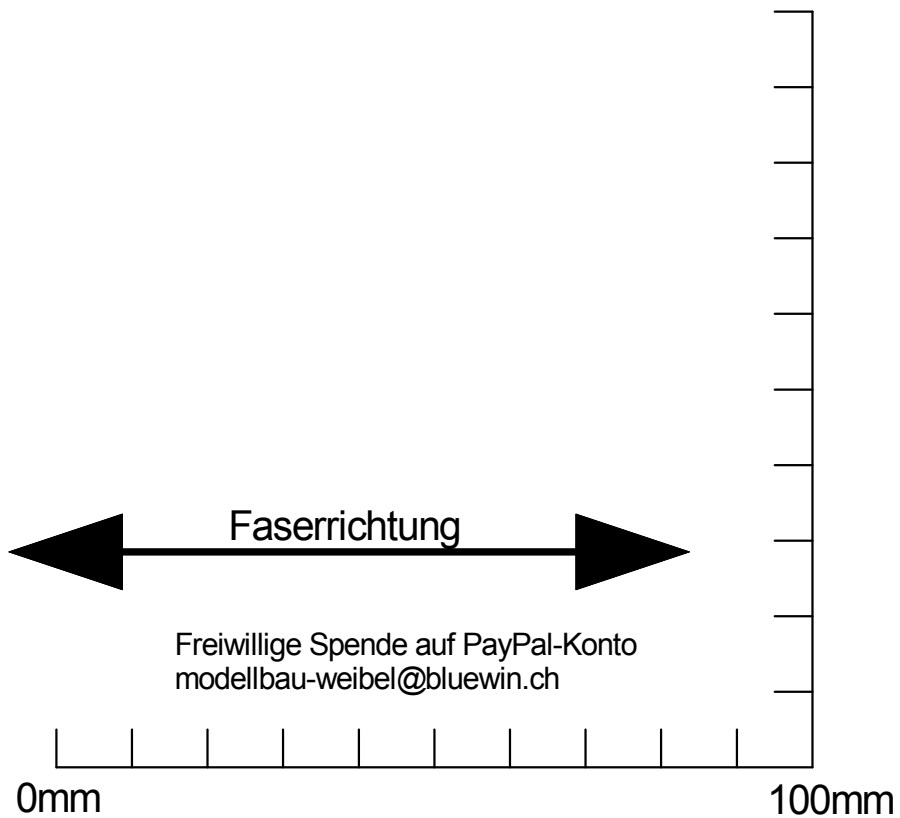
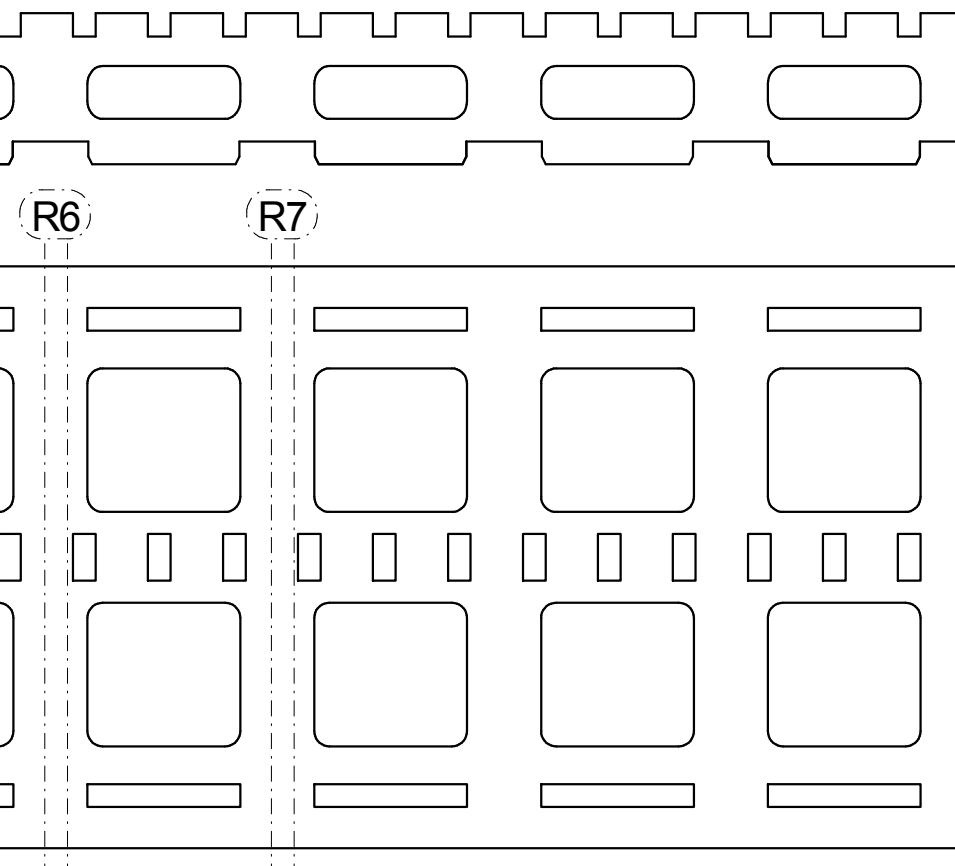

<h2>F-20 Tigershark M 1:11</h2>	
Spannweite: 700mm Läng : 1300mm Gewicht ab : 1450g Antrieb : Wemotec Mini fan evo Het 2W20 Akku : 4S 3000-3500mAh	
Akkuschacht, Anlenkung Bugfahrwerk-Servo Pappersperrholz 3mm	Martin Weibel modellbau-weibel@bluewin.ch www.modellbau-weibel.ch